



Micro-louvre Panel

IMPORTANT:

FOR YOUR SAFETY AND THE LONG-TERM RELIABILITY OF THIS PRODUCT, READ AND FOLLOW ALL INSTRUCTIONS TO PREVENT HARM TO THE LUMINAIRE, INSTALLER OR PROPERTY.

- * Installation requires knowledge of electrical and luminaire systems; installation must only be completed by a licenced or suitably qualified electrician.
- * Disconnect power before installation.
- * Do not alter pre-existing holes or drill new holes unless instructed to do so according to this manual.
- * Do not expose wiring to sharp objects or edges of sheet metal, always check clearances prior to any drilling and de-burr edges.
- * No components of this luminaire are serviceable by the user, and there is danger of personal and/or property harm if the luminaire is modified or disassembled.
- * If any luminaire components are damaged, they shall be exclusively replaced by the manufacturer or approved agent.

DIMENSIONS:

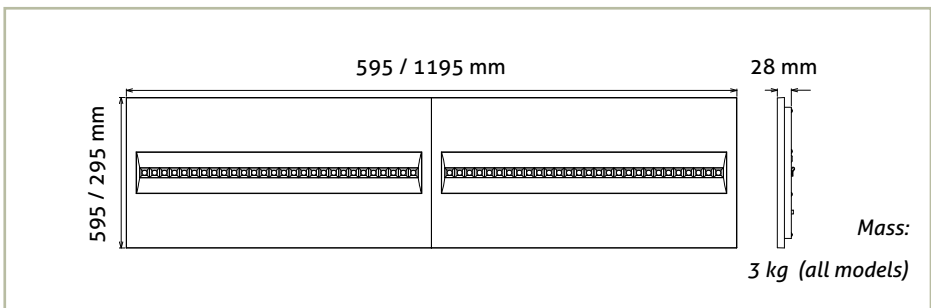

STANDARD SPECIFICATIONS

Power Factor	≥ 0.90 (230V)
Electrical Input	220-240 V / 50-60 Hz
Operating Temperatures	- 20 to +45 deg. C
Construction	Moulded plastic body
Ingress Protection	IP40
Impact Protection	N/A
Warranty	5 years

STANDARD MODELS

Product Code	Size	Power	Nominal Flux
EMP6X6W30W840	595 x 595 x 28 mm	30.5 W	3,600 lm
EMP6X6W35W840	595 x 595 x 28 mm	35.2 W	4,000 lm
EMP3X12W30W840	295 x 1195 x 28 mm	30.0 W	3,400 lm
EMP3X12W35W840	295 x 1195 x 28 mm	34.9 W	3,900 lm

INSTALLATION NOTES:

The following notes must be considered prior to installation of the product:

- * The luminaire has been designed to operate in accordance with the specifications listed above; please especially note the electrical input, operating temperature and ingress/impact protection specifications and ensure that the luminaire will only be operated within a suitable environment.
- * The luminaire must be securely fixed to a suitable surface or structure which is able to bear the luminaire weight and provide the necessary restraint under seismic loading according to NZS 4219.
- * The luminaire must be installed such that adequate space is available for ventilation to prevent overheating.
- * Exposure to UV (i.e. direct sunlight) over an extended period may cause discolouration of the diffuser and/or luminaire body.
- * The luminaire is not suitable for marine environments nor for hazardous or corrosive environments.

RECESSED INSTALLATION

1

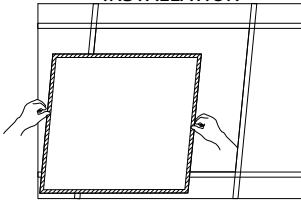

Ensure power is turned off, remove luminaire from packaging and ceiling tile in chosen location.

SUSPENDED INSTALLATION

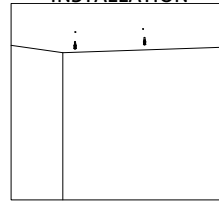

Ensure power is turned off, remove luminaire from packaging and knock the plastic anchor into ceiling.

2

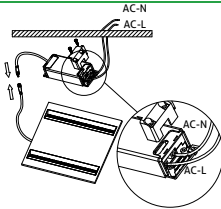

Connect the main AC wire L N to the terminal of driver respectively. Connect the DC plug between driver and micro-louvre panel.

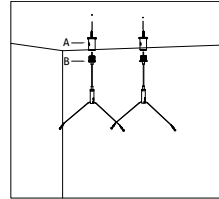

Fix part A with tapping screw to ceiling, wire rope goes through part B, and then screw B into A.

3

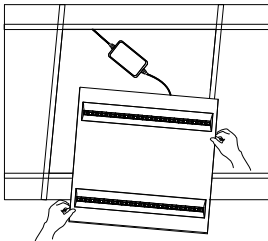

Fix the micro-louvre panel into plaster ceiling firmly.

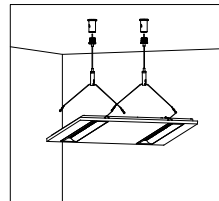

Hang the micro-louvre panel to the suspending wires, connect the DC plug between driver and panel.

4

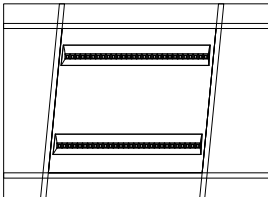

Connect power to mains supply and test the luminaire for correct operation and switching.

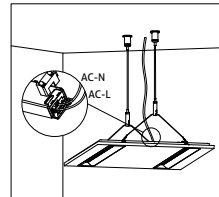

Connect the main AC wire "L" "N" to the terminal of driver respectively. Turn on power and test the luminaire for correct operation and switching.

MAINTENANCE:

- * To avoid risk of harm to the luminaire or maintenance personnel, always ensure that the luminaire is switched off and cooled down prior to undertaking any maintenance activities.
- * If maintenance tasks involve exposing any electrical components, ensure that mains power is disconnected prior to any works.
- * This product should only be cleaned with a damp cloth; do NOT use any chemical cleaning agents and/or solvents.
- * If dust accumulates on the inside of the diffuser, simply slide the end-caps of the luminaire body off, slide the diffuser out, wipe down with a damp cloth and allow to dry before reversing the process. CARE MUST BE TAKEN TO NOT TOUCH ANY LEDS AND NOT ALLOW ANY MOISTURE TO COME IN CONTACT WITH THE LEDS.
- * REMINDER: No components of this luminaire are serviceable by the user; damaged components may only be replaced or repaired by the manufacturer or approved agent.

WARRANTY COVER:

Ecopoint Limited guarantees this luminaire to be free from failures resulting from faulty materials or workmanship for a period of 5 years from the date of invoice. Retain the invoice as proof of purchase in the event of a warranty claim.

Failure resulting from misuse, accident, neglect or improper operation, maintenance, installation, modification or adjustment are not covered by this warranty.

Ecopoint Limited must be notified within 30 days of the alleged defect being first identified.

Please refer to standard Warranty Terms and Conditions of Sale for full detail; these are available at www.ecopoint.co.nz

CONTACT:

For any service or support enquiries, please call Ecopoint head office during normal business hours (Monday to Friday) or contact us via any of the means listed below.



Ecopoint Limited

2 Jarden Mile, Ngauranga, Wellington 6035
PO Box 12646, Thorndon, Wellington 6144

P: +64 4 499 3636 or
0800 695 949

E: info@ecopoint.co.nz
W: www.ecopoint.co.nz

Ref: EMP Installation Instruction (20181221)