

# Linear Bar integrated driver

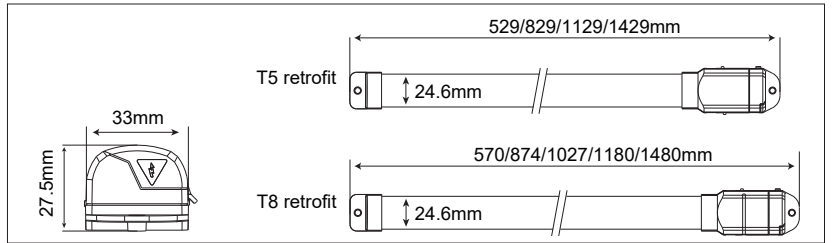





 IP20

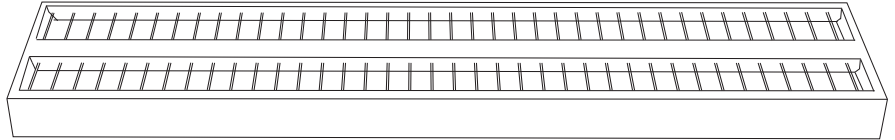
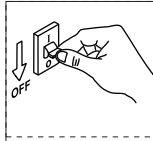

## General Safety Information

- Installation, commissioning and maintenance only by qualified electrician.
- Never perform any work on the luminaire with voltage applied. Danger to life due to electric shock!
- Electric connection must be appropriate according to all applicable standards and other national and international safety and accident prevention regulations.
- Damaged luminaires must not be operated.
- Observe and retain safety instructions and mounting instructions
- No liability is accepted for damages resulting from improper use.
- Use genuine parts only for repair.



①

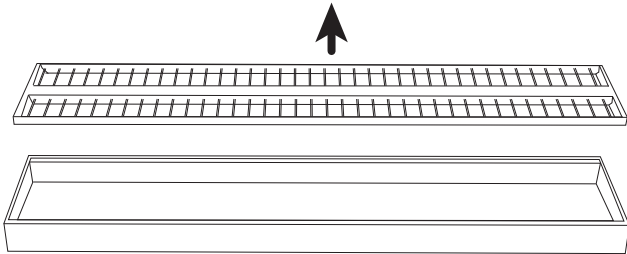

②

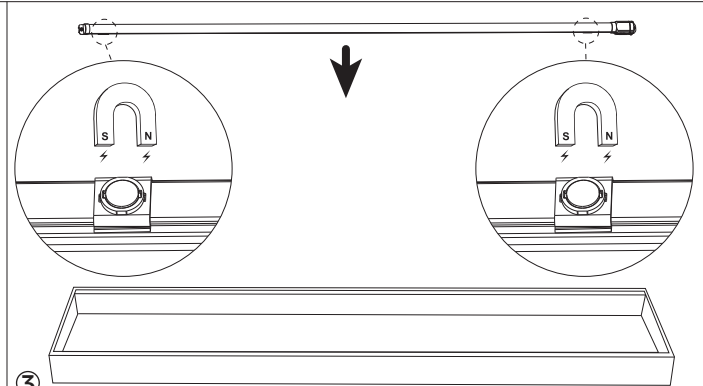

③

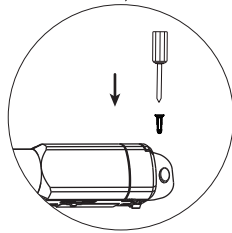
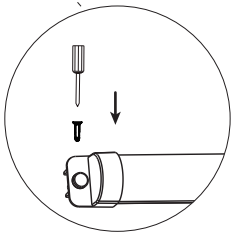
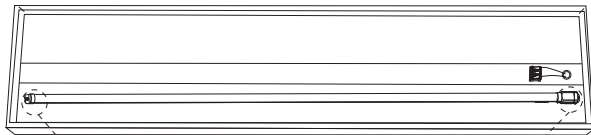

④

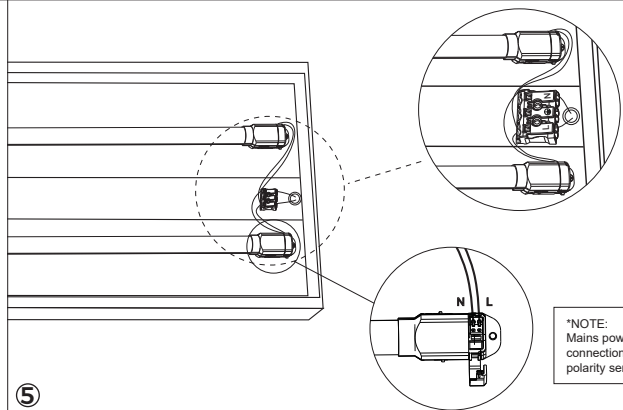

\*NOTE:  
Mains power  
connections NOT  
polarity sensitive

⑤

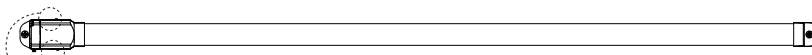

Power adjustable

Optional CCT adjustable

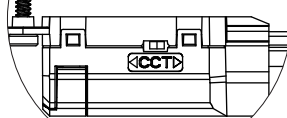
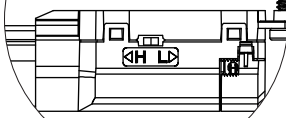

⑥

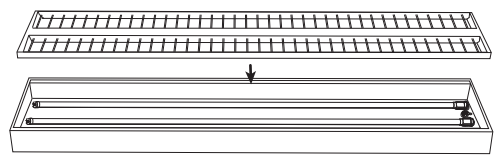

⑦

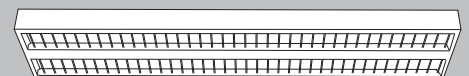

⑧

